

YX2745

45V_{IN}, 45V_{OUT}, Synchronous Bidirectional Boost Controller

PRODUCT INTRODUCTION

The YX2745 is a synchronous bidirectional boost controller suited for driving silicon (Si) MOSFET or Gallium Nitride (GaN) power transistors in highly efficient DC-DC power converters. It supports a wide input ranges up to 45V with maximum 98% power efficiency. It operate as a boost controller but can change the power path to reverse direction by controlling the DIR pin from high to low. It provides programmable input current limit and output current limit functions with output instant current monitoring through ISMON. The YX2745 integrates both high side and low side gate drivers with UVLO protections. It also supports adjustable dead time control for optimal turn on/off of power switches to reduce switching loss for high efficiency.

The YX2745 supports ultra-wide switching frequency range from 50KHz up to 3MHz with frequency set pin (RT). It also features external compensation, programmable soft-start to reduce the inrush current at startup. The YX2745 is available in 32-lead QFN package.

FEATURES

- Synchronous bidirectional boost controller with wide input voltage range of 2.7V to 45V
- **Bi-directional boost operation**
- Ultra-wide switching frequency: 50KHz to 3MHz
- Programmable output current limits, with load current sensing at ISMON
- 5V driver voltage for Si FETs or GaN FETs
- Gate driver: 0.6Ω pull-down, 1.2Ω pull-up resistance
- Drive supply rail UVLO protection
- Adjustable dead time control
- Integrated high accuracy (± 1%) 1.8V VREF
- 32-Lead side-wettable QFN Package

APPLICATIONS

- Energy storage system
- Consumer, Industrial and Automotive
- USB-C PD and Chargers
- Power Interrupt Protection System

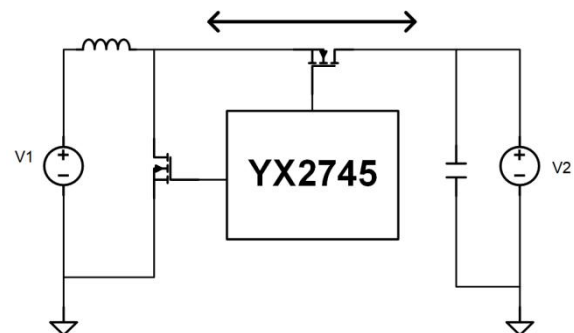

Simplified Circuit Diagram